



# FPF2200-FPF2202 Integrated Load Switch with 500mA High Precision Current Limit®

## Features

- 1.8 to 5.5V Input Voltage Range
- Typical  $R_{DS(ON)} = 140m\Omega @ V_{IN} = 5.5V$
- Typical  $R_{DS(ON)} = 160m\Omega @ V_{IN} = 3.3V$
- Fixed 500mA Current Limit (min)
- 5% Accurate Current Limit
- 72 $\Omega$  (typ) Output Discharge Resistance
- ESD Protected, above 8kV HBM and 2kV CDM

## Applications

- PDAs
- Cell Phones
- GPS Devices
- MP3 Players
- Digital Cameras
- Peripheral Ports
- Notebook Computer

## General Description

The FPF2200-FPF2202 are low  $R_{DS(ON)}$  P-Channel MOSFET load switches with high precision current limit value. The input voltage range operates from 1.8V to 5.5V to fulfill today's Ultra Portable Device's supply requirement. Switch control is by a logic input (ON) capable of interfacing directly with low voltage control signal. On-chip pull-down is available for output quick discharge when switch is turned off.

For the FPF2201, if the constant current condition still persists after 30ms, these parts will shut off the switch and pull the fault signal pin (FLAGB) low. The FPF2200 has an auto-restart feature which will turn the switch on again after 450ms if the ON pin is still active. The FPF2201 do not have this auto-restart feature so the switch will remain off until the ON pin is cycled. For the FPF2202, a current limit condition will immediately pull the fault signal pin low and the part will remain in the constant-current mode until the switch current falls below the current limit. For the FPF2200 through FPF2202, the minimum current limit is 500mA with 5% accuracy.

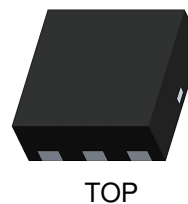
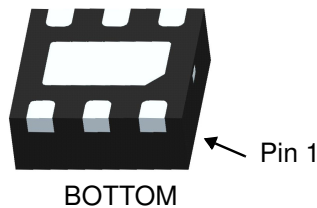

## Ordering Information

Part	Current Limit (mA)	Current Limit Blanking Time (mS)	Auto-Restart Time (mS)	ON Pin Activity
FPF2200	500	30	450	Active HI
FPF2201	500	30	NA	Active HI
FPF2202	500	NA	NA	Active HI

### Typical Application Circuit

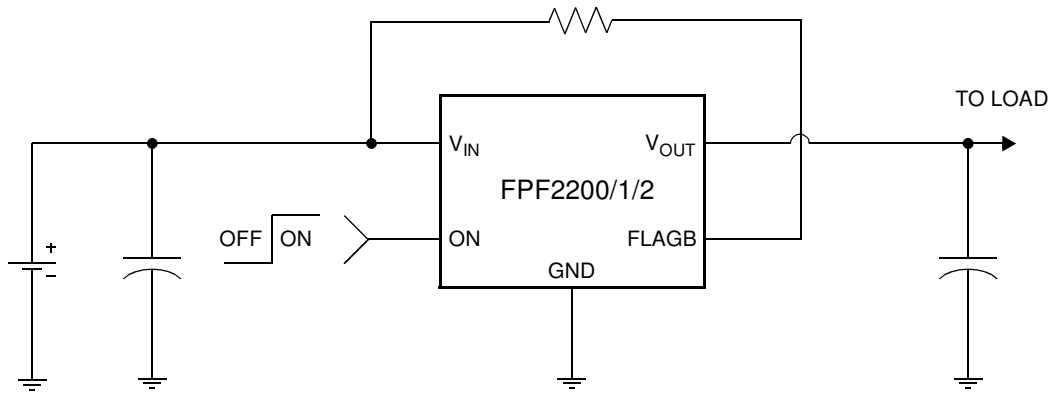

### Functional Block Diagram

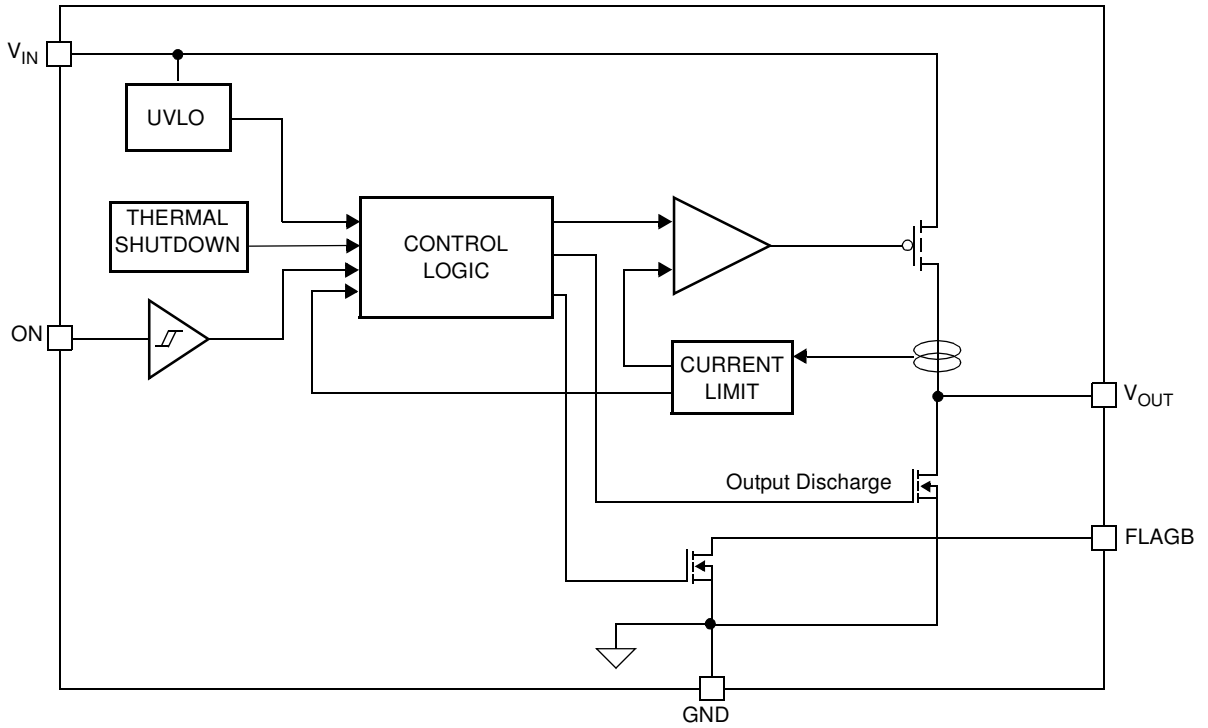

## Pin Configuration

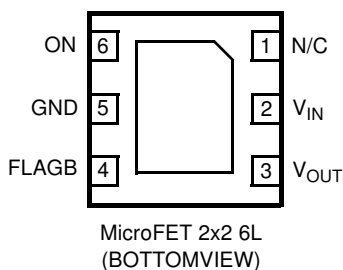

## Pin Description

Pin	Name	Function
1	N/C	No Connection
2	V <sub>IN</sub>	Supply Input: Input to the power switch and the supply voltage for the IC
3	V <sub>OUT</sub>	Switch Output: Output of the power switch
4	FLAGB	Fault Output: Active LO, open drain output which indicates an over current, supply under voltage or over temperature state
5	GND	Ground
6	ON	ON/OFF Control Input

## Absolute Maximum Ratings

Parameter	Min.	Max.	Unit
V <sub>IN</sub> , V <sub>OUT</sub> , ON, FLAGB TO GND	-0.3	6	V
Power Dissipation @ T <sub>A</sub> = 25 °C		1.2	W
Operating and Storage Junction Temperature	-65	125	°C
Thermal Resistance, Junction to Ambient		86	°C/W
Electrostatic Discharge Protection	HBM	8000	V
	MM	400	V
	CDM	2000	V

## Recommended Operating Range

Parameter	Min.	Max.	Unit
V <sub>IN</sub>	1.8	5.5	V
Ambient Operating Temperature, T <sub>A</sub>	-40	85	°C

## Electrical Characteristics

V<sub>IN</sub> = 1.8 to 5.5V, T<sub>A</sub> = -40 to +85 °C unless otherwise noted. Typical values are at V<sub>IN</sub> = 3.3V and T<sub>A</sub> = 25 °C.

Parameter	Symbol	Conditions	Min.	Typ.	Max.	Units
<b>Basic Operation</b>						
Operating Voltage	V <sub>IN</sub>		1.8		5.5	V
Quiescent Current	I <sub>Q</sub>	I <sub>OUT</sub> =0mA, V <sub>IN</sub> =V <sub>ON</sub> =1.8V		40	65	μA
		I <sub>OUT</sub> =0mA, V <sub>IN</sub> =V <sub>ON</sub> =3.3V		45	75	
		I <sub>OUT</sub> =0mA, V <sub>IN</sub> =V <sub>ON</sub> =5.5V		55	85	
V <sub>IN</sub> Shutdown Current		V <sub>ON</sub> =0V, V <sub>IN</sub> =5.5V, V <sub>OUT</sub> =short to GND			2.5	μA

Parameter	Symbol	Conditions	Min.	Typ.	Max.	Units
$V_{OUT}$ Shutdown Current		$V_{ON}=0V$ , $V_{OUT}=5.5V$ , $V_{IN}$ =short to GND			1	$\mu A$
On-Resistance	$R_{ON}$	$V_{IN}=5.5V$ , $I_{OUT}=200mA$ , $T_A=25^\circ C$		140	185	m $\Omega$
		$V_{IN}=3.3V$ , $I_{OUT}=200mA$ , $T_A=25^\circ C$		160	210	
		$V_{IN}=1.8V$ , $I_{OUT}=200mA$ , $T_A=25^\circ C$		230	300	
		$V_{IN}=3.3V$ , $I_{OUT}=200mA$ , $T_A=-40^\circ C$ to $85^\circ C$	90		265	
Output Discharge Resistance		$V_{IN}=3.3V$ , $V_{ON}=0V$ , $I_{OUT}=10mA$		72	105	$\Omega$
ON Input Logic High Voltage (ON)	$V_{IH}$	$V_{IN}=1.8V$	0.8			V
		$V_{IN}=5.5V$	1.4			
ON Input Logic Low Voltage (OFF)	$V_{IL}$	$V_{IN}=1.8V$			0.5	V
		$V_{IN}=5.5V$			1.0	
On Input Leakage		$V_{ON} = V_{IN}$ or GND	-1		1	$\mu A$
FLAGB Output Logic Low Voltage		$V_{IN}=5.5V$ , $I_{SINK}=100\mu A$		0.05	0.1	V
		$V_{IN}=1.8V$ , $I_{SINK}=100\mu A$		0.12	0.25	
FLAGB Output High Leakage Current		$V_{IN}=5.5V$ , Switch on			1	$\mu A$

Protections						
Current Limit	$I_{LIM}$	$V_{IN}=3.3V$ , $V_{OUT} = 3.0V$ , $T_A=25^\circ C$	504	530	557	mA
Thermal Shutdown		Shutdown Threshold		140		$^\circ C$
		Return from Shutdown		130		
		Hysteresis		10		
Under Voltage Shutdown	UVLO	$V_{IN}$ increasing	1.55	1.65	1.75	V
Under Voltage Shutdown Hysteresis				50		mV
Dynamic						
Turn On Time	$t_{ON}$	$R_L=500\Omega$ , $C_L=0.001\mu F$		70		$\mu S$
Turn Off Time	$t_{OFF}$	$R_L=500\Omega$ , $C_L=0.001\mu F$		600		nS
$V_{OUT}$ Rise Time	$t_{RISE}$	$R_L=500\Omega$ , $C_L=0.001\mu F$		40		$\mu S$
$V_{OUT}$ Fall Time	$t_{FALL}$	$R_L=500\Omega$ , $C_L=0.001\mu F$		100		nS
Over Current Blanking Time	$t_{BLANK}$	FPF2200, FPF2201	15	30	60	mS
Auto-Restart Time	$t_{RSTRT}$	FPF2200	225	450	900	mS
Current Limit Response Time		$V_{IN} = V_{ON} = 3.3V$ . Over-Current Condition: $R_{LOAD}=1.55\Omega$		5		$\mu S$

## Typical Characteristics

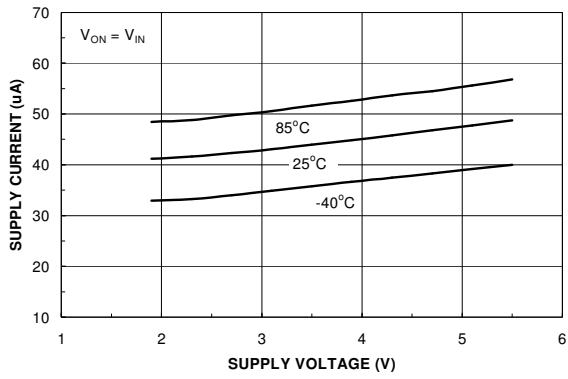

Figure 1. Quiescent Current vs. Input Voltage

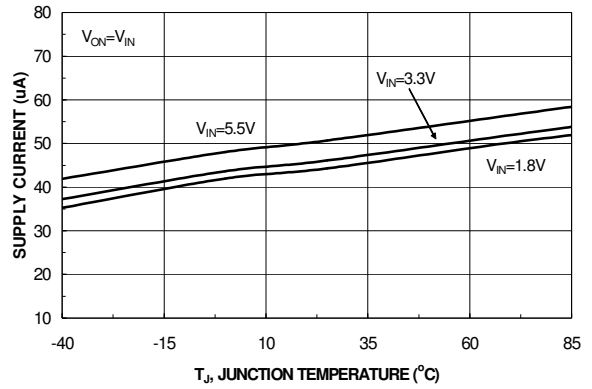

Figure 2. Quiescent Current vs. Temperature

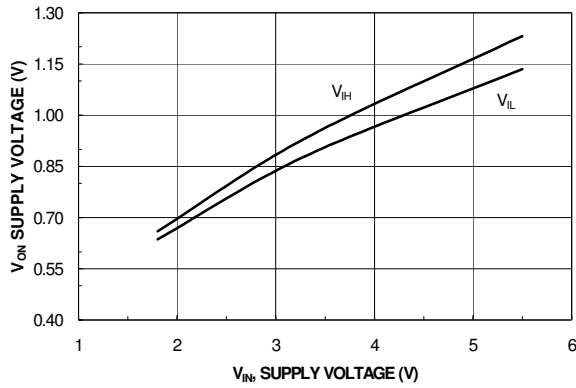

Figure 3.  $V_{ON}$  vs. Input Voltage

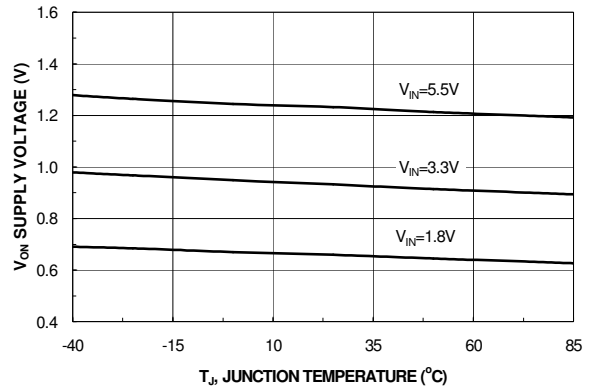

Figure 4.  $V_{ON}$  High Voltage vs. Temperature

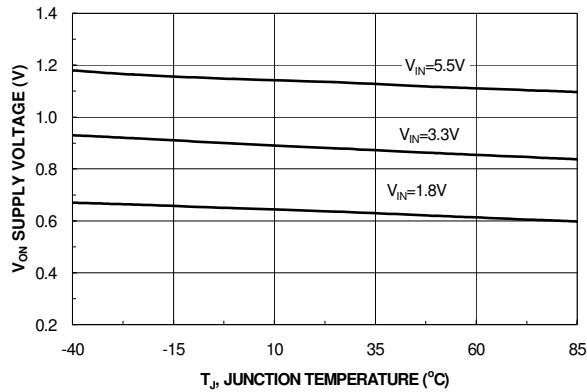

Figure 5.  $V_{ON}$  Low Voltage vs. Temperature

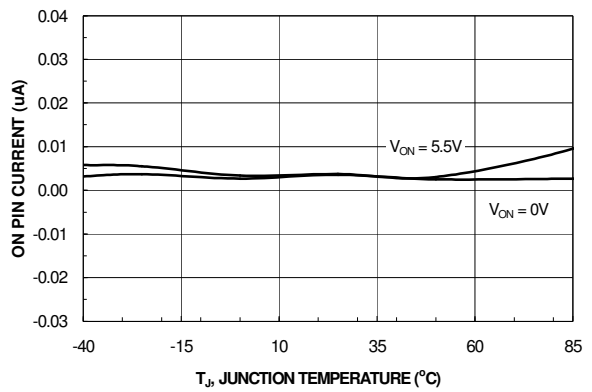

Figure 6. On Pin Current vs. Temperature

## Typical Characteristics

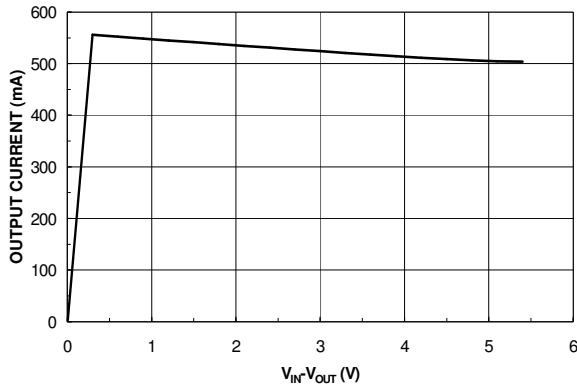

Figure 7. Current Limit vs. Output Voltage

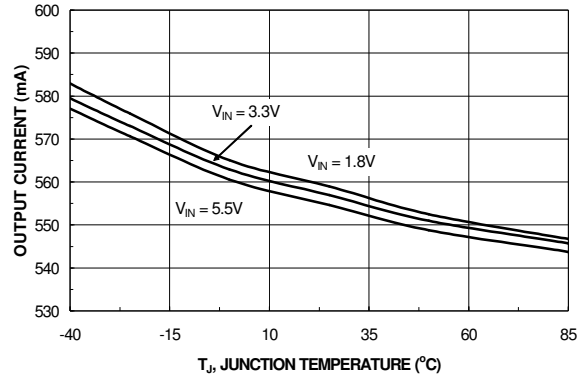

Figure 8. Current Limit vs. Temperature

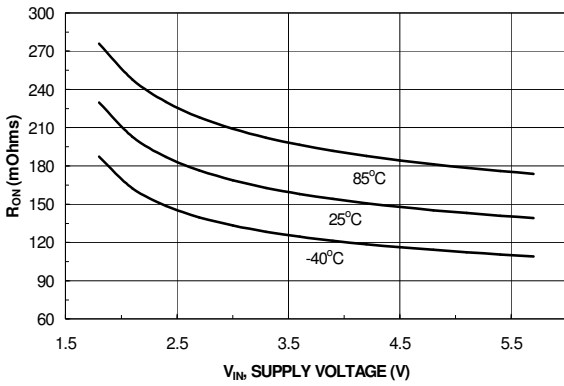

Figure 9.  $R_{ON}$  vs. Input Voltage

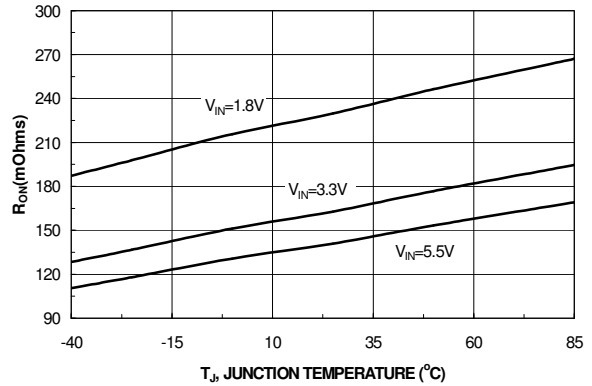

Figure 10.  $R_{ON}$  vs. Temperature

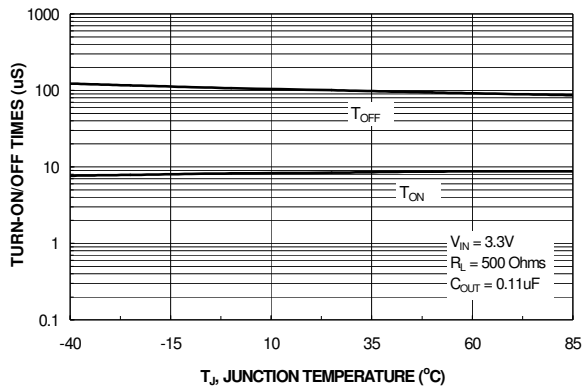

Figure 11.  $T_{ON}$  /  $T_{OFF}$  vs. Temperature

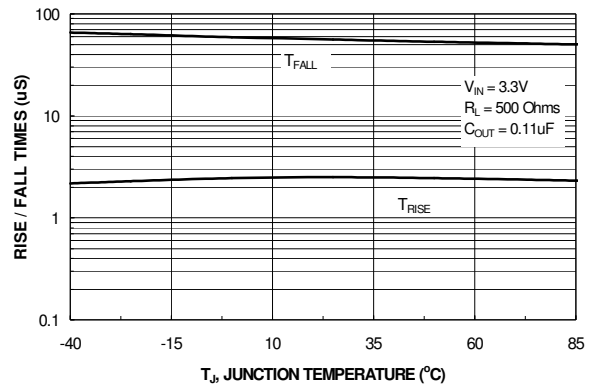

Figure 12.  $T_{RISE}$  /  $T_{FALL}$  vs. Temperature

## Typical Characteristics

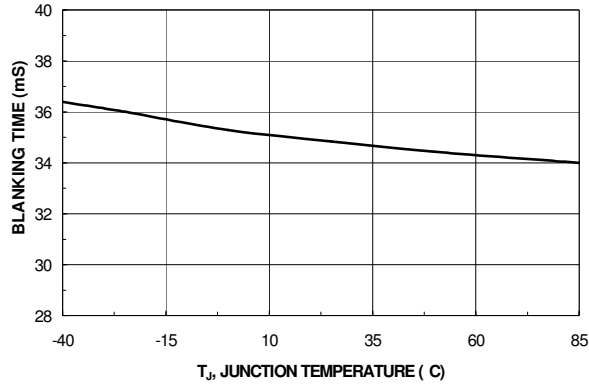

Figure 13. T<sub>BLANK</sub> vs Temperature

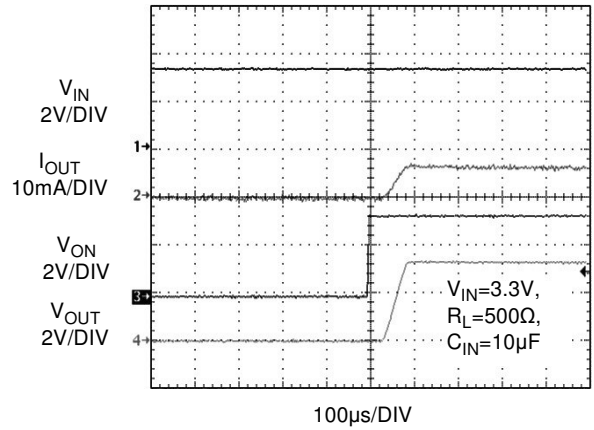

Figure 14. T<sub>ON</sub> Response

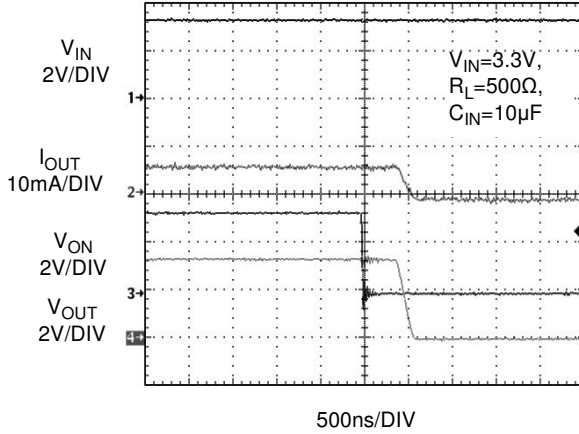

Figure 15. T<sub>OFF</sub> Response

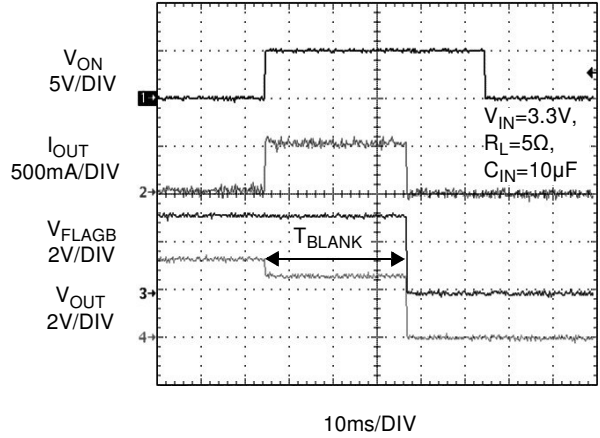

Figure 16. T<sub>BLANK</sub> Response

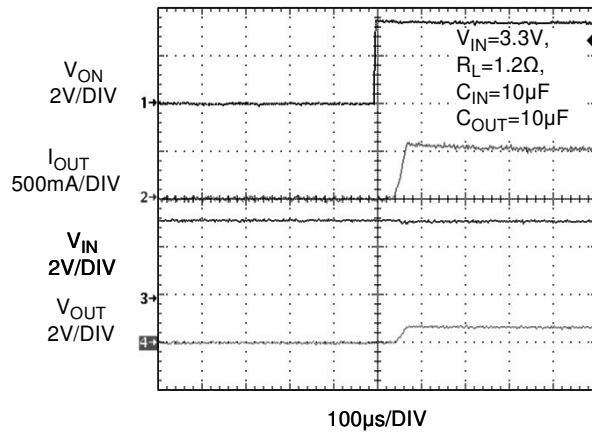

Figure 17. Current Limit Response  
(Output is loaded with 1.2Ω resistor and C<sub>OUT</sub>=10μF)

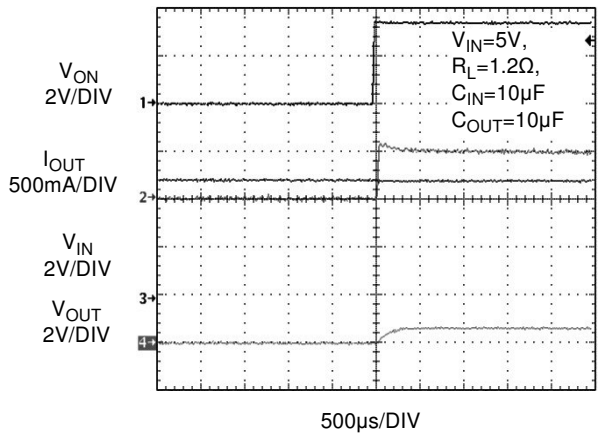

Figure 18. Current Limit Response  
(Output is loaded with 1.2Ω resistor and C<sub>OUT</sub>=10μF)

Typical Characteristics

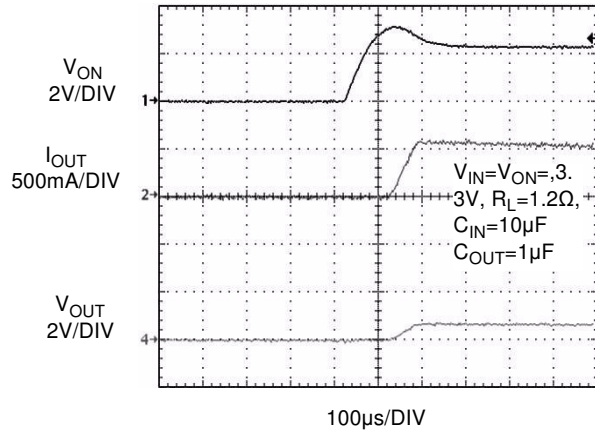

Figure 19. Current Limit Response  
(Switch is powered into a short - Input and enable pins are tied together)

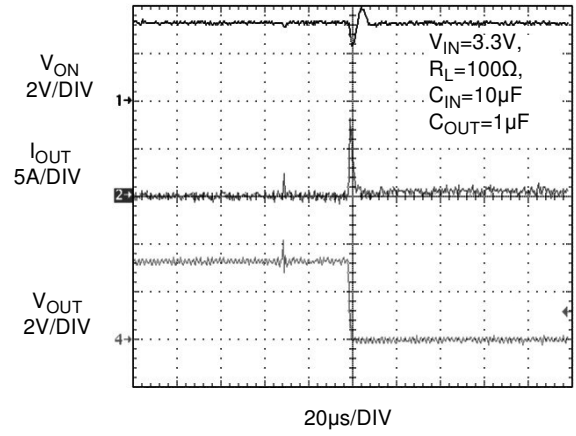

Figure 20. Current Limit Response  
(Output shorted to GND while the switch is in normal operation)



## Description of Operation

The FPF2200, FPF2201, and FPF2202 are state of the art High Precision Current Limit switches designed to meet USB OTG (On-The-Go) applications with optimum current for a safe design practice. The core of each device is a 0.16Ω P-channel MOSFET and a controller capable of functioning over an input operating range of 1.8- 5.5V. The controller protects or offers current limiting, UVLO(undervoltage lockout) and thermal shutdown protection. The minimum current limit value is set to 500mA allowing to draw as much as 500mA from the USB port.

### On/Off Control

The ON pin is active high, and controls the state of the switch. Applying a continuous high signal will hold the switch in the ON state. The switch will move into the OFF state when the active high is removed, or if a fault is encountered. For all versions, an undervoltage on  $V_{IN}$  or a junction temperature in excess of 140°C overrides the ON control to turn off the switch.

In addition, excessive currents will cause the switch to turn off in the FPF2200 and FPF2201. The FPF2200 has an Auto-Restart feature which will automatically turn the switch ON again after 450ms. For the FPF2201, the ON pin must be toggled to turn-on the switch again. The FPF2202 does not turn off in response to an over current condition but instead remains operating in a constant current mode so long as ON is active and the thermal shutdown or UVLO have not activated.

### Fault Reporting

Upon the detection of an over-current condition, an input UVLO, or an over-temperature condition, the FLAGB signals the fault mode by activating LO. In the event of an over-current condition for the FPF2200 and FPF2201, the FLAGB goes LO at the end of the blanking time while FLAGB goes LO immediately for the FPF2202. If the over-current condition lasts longer than blanking time, FLAGB remains LO through the Auto-Restart Time for the FPF2200 while for the FPF2201, FLAGB is latched LO and ON must be toggled to release it. With the FPF2202, FLAGB is LO during the faults and immediately returns HI at the end of the fault condition. FLAGB is an open-drain MOSFET which requires a pull-up resistor between  $V_{IN}$  and FLAGB. During shutdown, the pull-down on FLAGB is disabled to reduce current draw from the supply. A 100KΩ pull up resistor is recommended to be used in the application.

### Current Limiting

The current limit ensures that the current through the switch doesn't exceed a maximum value while not limiting at less than a minimum value. The minimum current at which the parts will limit is set to 500mA. The FPF2200 and FPF2201 have a blanking time of 30ms (nominal) during which the switch will act as a constant current source. At the end of the blanking time, the switch will be turned-off. The FPF2202 has no current limit blanking period so it will remain in a constant current state until the ON pin is deactivated or the thermal shutdown turns-off the switch.

### Undervoltage Lockout (UVLO)

The undervoltage lockout turns-off the switch if the input voltage drops below the undervoltage lockout threshold. With the ON pin active the input voltage rising above the undervoltage lockout threshold will cause a controlled turn-on of the switch which limits current over-shoots.

### Output Discharge Resistor

The FPF2200/1/2 family contains an 80Ω on-chip load resistor for quick output discharge when the switch is turned off. This feature becomes more attractive when application requires large output capacitor to be discharged when switch turns-off. However,  $V_{OUT}$  pin should not be connected directly to the battery source due to the discharge mechanism of the load switch.

### Thermal Shutdown

The thermal shutdown protects the die from internally or externally generated excessive temperatures. During an over-temperature condition the FLAGB is activated and the switch is turned-off. The switch automatically turns-on again if temperature of the die drops below the threshold temperature.

## Application Information

### Input Capacitor

To limit the voltage drop on the input supply caused by transient in-rush currents when the switch is turned on into a discharged load capacitor or a short-circuit, a capacitor is recommended to be placed between  $V_{IN}$  and GND. A 1 $\mu$ F ceramic capacitor,  $C_{IN}$ , placed close to the pins is usually sufficient. Higher values of  $C_{IN}$  can be used to further reduce the voltage drop.

### Output Capacitor

A 0.1 $\mu$ F capacitor  $C_{OUT}$ , should be placed between  $V_{OUT}$  and GND. This capacitor will prevent parasitic board inductances from forcing  $V_{OUT}$  below GND when the switch turns-off. For the FPF2200 and FPF2201, the total output capacitance needs to be kept below a maximum value,  $C_{OUT(max)}$ , to prevent the part from registering an over-current condition and turning-off the switch. The maximum output capacitance can be determined from the following formula:

$$C_{OUT(Max)} = \frac{I_{LIM(Max)} \times t_{BLANK(Min)}}{V_{IN}}$$

### Power Dissipation

During normal on-state operation, the power dissipated in the device will depend upon the level at which the current limit is set. The maximum allowed setting for the current limit is 500mA and will result in a power dissipation of:

$$P = (I_{LIM})^2 \times R_{ON} = (0.5)^2 \times 0.16 = 40mW$$

If the part goes into current limit, the maximum power dissipation will occur when the output is shorted to ground. For the FPF2200, the power dissipation will scale by the Auto-Restart Time,  $t_{RSTRT}$ , and the Over Current Blanking Time,  $t_{BLANK}$ , so that the maximum power dissipated is:

$$P_{(Max)} = \frac{t_{BLANK}}{t_{BLANK} + t_{RSTRT}} \times V_{IN(Max)} \times I_{LIM(Max)}$$

$$= \frac{30}{30 + 450} \times 5.5 \times 0.5 = 0.17W$$

Note this is below the maximum package power dissipation, and the thermal shutdown feature will act as additional safety to protect the part from damage due to excessive heating. The junction temperature is only able to increase to the thermal shutdown threshold. Once this temperature has been reached, toggling ON will not turn-on the switch until the junction temperature drops. For the FPF2202, a short on the output will cause the part to operate in a constant current state dissipating a worst case power of:

$$P_{(Max)} = V_{IN(MAX)} \times I_{LIM(MAX)} = 5.5 \times 0.557 = 3.064W$$

This large amount of power will activate the thermal shutdown and the part will cycle in and out of thermal shutdown so long as the ON pin is active and the short is present.

### PCB Layout Recommendations

For best performance, all traces should be as short as possible. To be more effective, the input and output capacitors should be placed close to the device to minimize the effects that parasitic trace inductances may have on normal and short-circuit operation. Using wide traces for  $V_{IN}$ ,  $V_{OUT}$  and GND will help minimize parasitic electrical effects along with minimizing the case to ambient thermal impedance.

### Improving Thermal Performance

An improper layout could result in higher junction temperature and triggering the thermal shutdown protection feature. This concern applies when the switch is set at higher current limit value and an over-current condition occurs. In this case, the power dissipation of the switch, from the formula below, could exceed the maximum absolute power dissipation of 1.2W.

$$PD = (V_{IN} - V_{OUT}) \times I_{LIM(Max)}$$

The following techniques have been identified to improve the thermal performance of this family of devices. These techniques are listed in order of the significance of their impact.

1. Thermal performance of the load switch can be improved by connecting pin7 of the DAP (Die Attach Pad) to the GND plane of the PCB.
2. Embedding two exposed through-hole vias into the DAP (pin7) provides a path for heat to transfer to the back GND plane of the PCB. A drill size of Round, 14 mils (0.35mm) with 1-ounce copper plating is recommended to result in appropriate solder reflow. A smaller size hole prevents the solder from penetrating into the via, resulting in device lift-up. Similarly, a larger via-hole consumes excessive solder, and may result in voiding of the DAP.

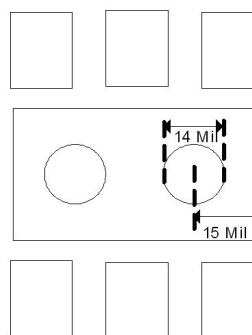

Figure 21: Two through hole open vias embedded in DAP

3. The  $V_{IN}$ ,  $V_{OUT}$  and GND pins will dissipate most of the heat generated during a high load current condition. The layout suggested in Figure 23 provides each pin with adequate copper so that heat may be transferred as efficiently as possible out of the device. The low-power FLAGB and ON pin traces may be laid-out diagonally from the device to maximize the area available to the ground pad. Placing the input and output capacitors as close to the device as possible also contributes to heat dissipation, particularly during high load currents.

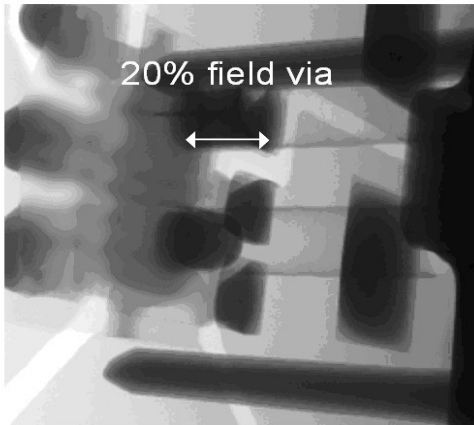

Figure 22: X-Ray result (bottom view with 45° angle)

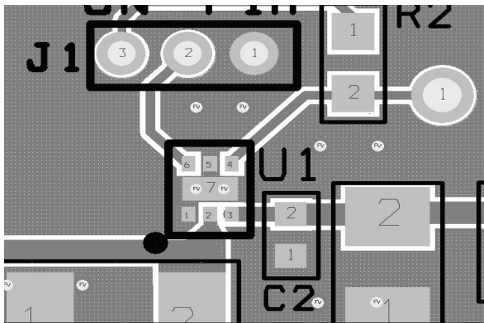
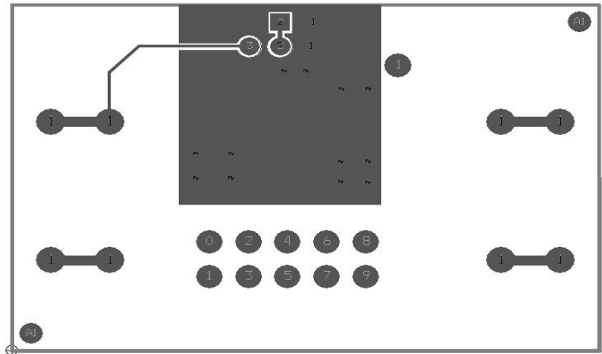

Figure 23: Proper layout of output and ground copper area

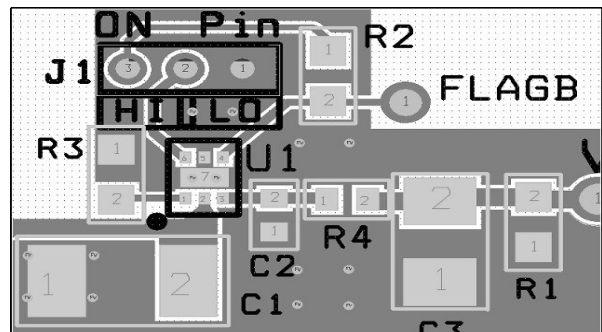

Figure 25: Bottom and ASB Layers

Figure 26: Zoom in to Top layer

**FPF22XX Demo Board**

FPF22XX Demo board has components and circuitry to demonstrate FPF2223/4/5 load switches functions and features. R4 resistor with 0Ω value is used for measuring the output current. Load current can be scoped by removing the R4 resistor and soldering a current loop to the R4 footprint. Thermal performance of the board is improved using a few techniques recommended in the layout recommendations section of datasheet. R3 resistor should be left open for FPF220X family.

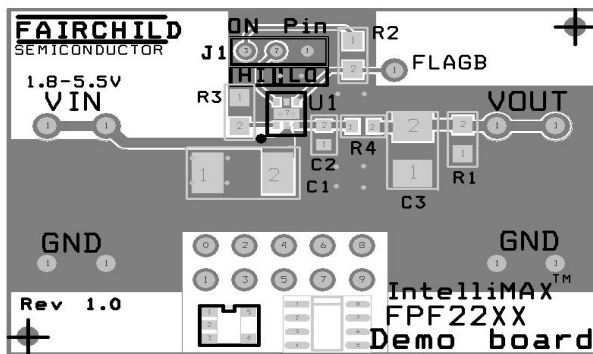
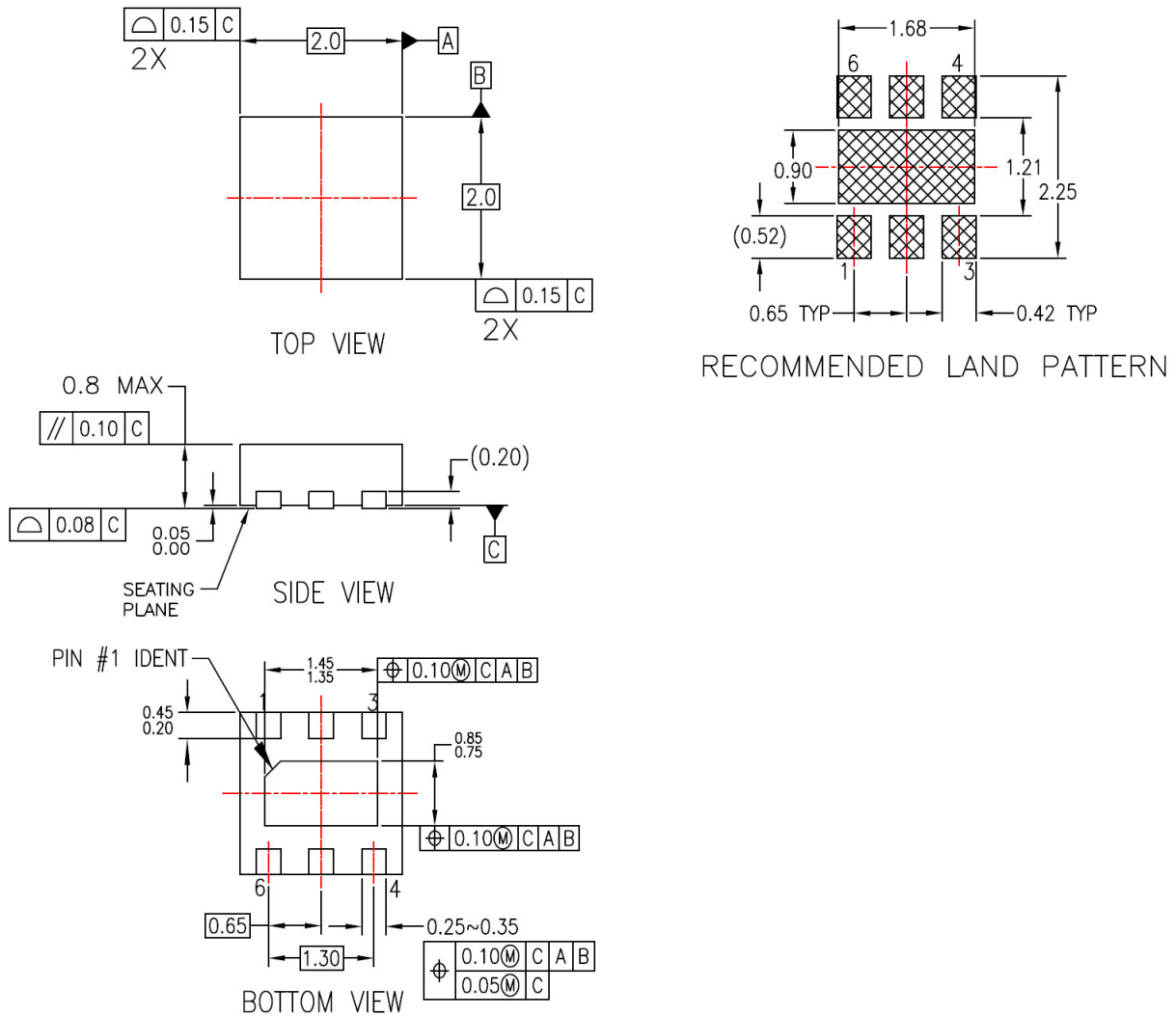

Figure 24: Top, SST, and AST Layers

**Dimensional Outline and Pad Layout**



**NOTES:**





- A. NON-CONFORMS TO JEDEC REGISTRATION,
- B. DIMENSIONS ARE IN MILLIMETERS.
- C. DIMENSIONS AND TOLERANCES PER ASME Y14.5M, 1994

MLP06KrevA



**TRADEMARKS**

The following includes registered and unregistered trademarks and service marks, owned by Fairchild Semiconductor and/or its global subsidiaries, and is not intended to be an exhaustive list of all such trademarks.

- |   |  |   |   |
|---|--|---|---|
| ACEx <sup>®</sup>   | FPST <sup>™</sup>                            | PDP SPM <sup>™</sup>  | The Power Franchise <sup>®</sup>  |
| Build it Now <sup>™</sup>   | F-PFS <sup>™</sup>                           | Power-SPM <sup>™</sup>  | the power franchise   |
| CorePLUS <sup>™</sup>   | FRFET <sup>®</sup>                           | PowerTrench <sup>®</sup>  | TinyBoost <sup>™</sup>  |
| CorePOWER <sup>™</sup>  | Global Power Resource <sup>SM</sup>          | Programmable Active Droop <sup>™</sup>  | TinyBuck <sup>™</sup>   |
| CROSSVOL <sup>™</sup>   | Green FPS <sup>™</sup>                       | QFET <sup>®</sup>   | TinyLogic <sup>®</sup>  |
| CTL <sup>™</sup>  | Green FPS <sup>™</sup> e-Series <sup>™</sup> | QS <sup>™</sup>   | TINYOPTO <sup>™</sup>   |
| Current Transfer Logic <sup>™</sup>   | GTO <sup>™</sup>                             | Quiet Series <sup>™</sup>   | TinyPower <sup>™</sup>  |
| EcoSPARK <sup>®</sup>   | IntelliMAX <sup>™</sup>                      | RapidConfigure <sup>™</sup>   | TinyPWM <sup>™</sup>  |
| EfficientMax <sup>™</sup>   | ISOPLANAR <sup>™</sup>                       | Saving our world, 1mW at a time <sup>™</sup>                                      | TinyWire <sup>™</sup>   |
| EZSWITCH <sup>™</sup> *   | MegaBuck <sup>™</sup>                        | SmartMax <sup>™</sup>   | μSerDes <sup>™</sup>  |
|  ™ | MICROCOUPLER <sup>™</sup>                    | SMART START <sup>™</sup>  |  ™ |
|  ™ | MicroFET <sup>™</sup>                        | SPM <sup>®</sup>  | UHC <sup>®</sup>  |
| Fairchild <sup>®</sup>  | MicroPak <sup>™</sup>                        | STEALTH <sup>™</sup>  | Ultra FRFET <sup>™</sup>  |
| Fairchild Semiconductor <sup>®</sup>  | MillerDrive <sup>™</sup>                     | SuperFET <sup>™</sup>   | UniFET <sup>™</sup>   |
| FACT Quiet Series <sup>™</sup>  | MotionMax <sup>™</sup>                       | SuperSOT <sup>™</sup> -3  | VCX <sup>™</sup>  |
| FACT <sup>®</sup>   | Motion-SPM <sup>™</sup>                      | SuperSOT <sup>™</sup> -6  | VisualMax <sup>™</sup>  |
| FAST <sup>®</sup>   | OPTOLOGIC <sup>®</sup>                       | SuperSOT <sup>™</sup> -8  |   |
| FAST <sup>®</sup>   | OPTOPLANAR <sup>®</sup>                      | SupreMOS <sup>™</sup>   |   |
| FastvCore <sup>™</sup>  |  | SyncFET <sup>™</sup>  |   |
| FlashWriter <sup>®</sup> *  |  |  |   |

\* EZSWITCH<sup>™</sup> and FlashWriter<sup>®</sup> are trademarks of System General Corporation, used under license by Fairchild Semiconductor.

**DISCLAIMER**

FAIRCHILD SEMICONDUCTOR RESERVES THE RIGHT TO MAKE CHANGES WITHOUT FURTHER NOTICE TO ANY PRODUCTS HEREIN TO IMPROVE RELIABILITY, FUNCTION, OR DESIGN. FAIRCHILD DOES NOT ASSUME ANY LIABILITY ARISING OUT OF THE APPLICATION OR USE OF ANY PRODUCT OR CIRCUIT DESCRIBED HEREIN; NEITHER DOES IT CONVEY ANY LICENSE UNDER ITS PATENT RIGHTS, NOR THE RIGHTS OF OTHERS. THESE SPECIFICATIONS DO NOT EXPAND THE TERMS OF FAIRCHILD'S WORLDWIDE TERMS AND CONDITIONS, SPECIFICALLY THE WARRANTY THEREIN, WHICH COVERS THESE PRODUCTS.

**LIFE SUPPORT POLICY**

FAIRCHILD'S PRODUCTS ARE NOT AUTHORIZED FOR USE AS CRITICAL COMPONENTS IN LIFE SUPPORT DEVICES OR SYSTEMS WITHOUT THE EXPRESS WRITTEN APPROVAL OF FAIRCHILD SEMICONDUCTOR CORPORATION.

As used herein:

- Life support devices or systems are devices or systems which, (a) are intended for surgical implant into the body or (b) support or sustain life, and (c) whose failure to perform when properly used in accordance with instructions for use provided in the labeling, can be reasonably expected to result in a significant injury of the user.
- A critical component in any component of a life support, device, or system whose failure to perform can be reasonably expected to cause the failure of the life support device or system, or to affect its safety or effectiveness.

**PRODUCT STATUS DEFINITIONS**

**Definition of Terms**

Datasheet Identification	Product Status	Definition
Advance Information	Formative / In Design	This datasheet contains the design specifications for product development. Specifications may change in any manner without notice.
Preliminary	First Production	This datasheet contains preliminary data; supplementary data will be published at a later date. Fairchild Semiconductor reserves the right to make changes at any time without notice to improve design.
No Identification Needed	Full Production	This datasheet contains final specifications. Fairchild Semiconductor reserves the right to make changes at any time without notice to improve the design.
Obsolete	Not In Production	This datasheet contains specifications on a product that is discontinued by Fairchild Semiconductor. The datasheet is for reference information only.

Rev. I34